

相机端

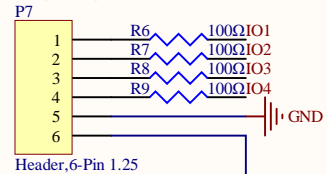

Header, 6-Pin 1.25

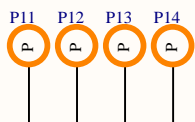

ESD

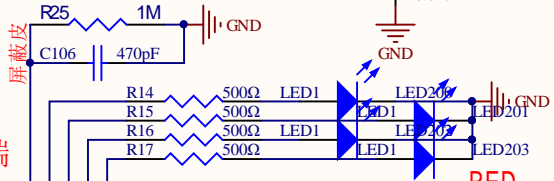
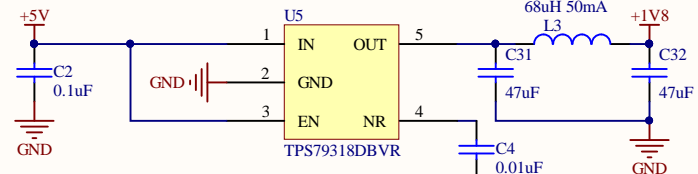
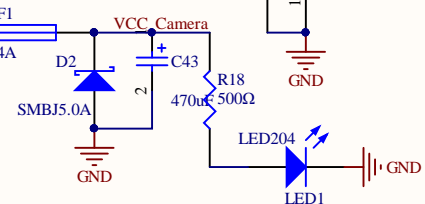
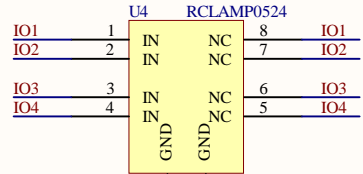

客户端

I/O

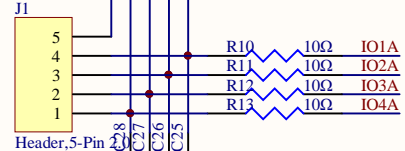

Header, 5-Pin

Power

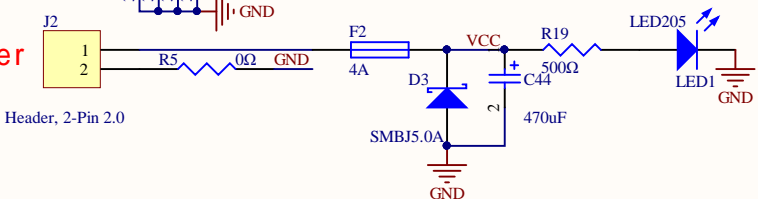

Header, 2-Pin 2.0

跳线

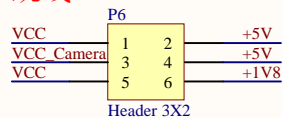

I/O电平转换

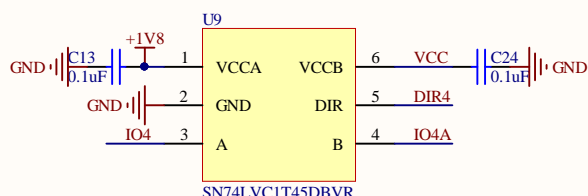
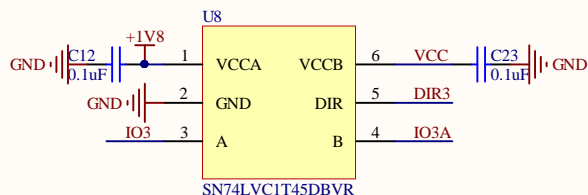
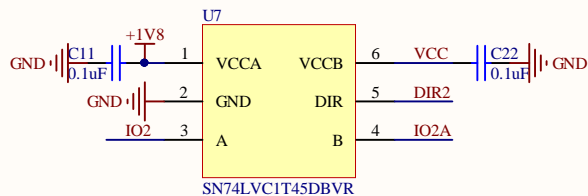
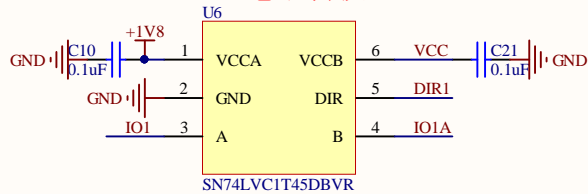

ESD

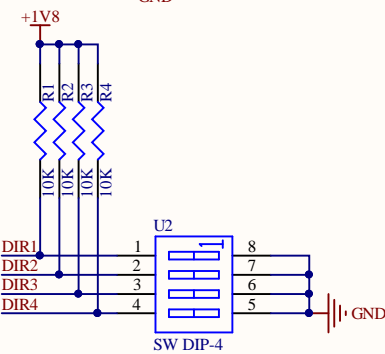
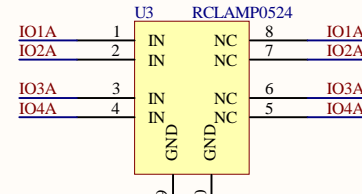

拨码开关

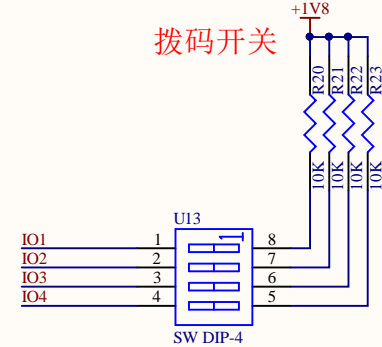

拨码开关

	6芯	5芯		
客户端	跳线	客户端	跳线	
+5V	3 - 4	+5V	1 - 2	
+3V3	3 - 4	+3V3	1 - 2	
+1V8	3 - 4	+1V8	5 - 6	

Title *		
Size: A4	Number: *	Revision: *
Date: 2021/1/18	Time: 9:46:04	Sheet * of *
File: D:\...\QHY_Level translator_V2A\QHY_Level translator_V2A.SchDoc		

